

Benchtop Centrifuge

1-6

**OPERATING MANUAL**



Dear customer,

Congratulations for purchasing a SIGMA laboratory centrifuge. You have selected a device which combines many advantages.

The electronic operation control allows a trouble-free use of the centrifuge. With its 3-phase drive, maintenance-free quiet operation without any carbon dust pollution is guaranteed.

Your device is equipped with user-friendly options which make the operation and standard settings easier for you. Built-in error-detecting functions keep the user from entering incorrect values and check the complete operation.

All settings are executed via the control panel with a coated surface which protects the device against moisture and dust. In addition, the interior of the centrifuge is also easy to clean. We offer you a device that combines functional variety with practical applications.

We thank you for your confidence and wish you a successful application of the centrifuge.

SIGMA Laborzentrifugen GmbH  
P.O. Box 1713 - 37507 Osterode/Germany  
Phone 05522/5007-0 - Fax 05522/500712  
Internet: [www.sigma-zentrifugen.de](http://www.sigma-zentrifugen.de)  
eMail: [info@sigma-zentrifugen.de](mailto:info@sigma-zentrifugen.de)  
SIGMA Service-Tel. 05522/5007-25



**Konformitätserklärung**  
(73/23/EWG; 89/336/EWG; 98/37/EWG)  
**Statement of Conformity**  
(73/23/CEE; 89/336/CEE; 98/37/CEE)  
**Déclaration de conformité**  
(73/23/CEE; 89/336/CEE; 98/37/CEE)

Die nachfolgend bezeichnete Maschine wurde in Übereinstimmung mit den Richtlinien 73/23/EWG; 89/336/EWG und 98/37/EWG hergestellt und geprüft.

The following machine is manufactured and tested in compliance with directions 73/23/CEE; 89/336/CEE and 98/37/CEE.

La machine désignée ci-dessous est produit et examiné conforme aux directives 73/23/CEE; 89/336/CEE et 98/37/CEE

Bezeichnung der Maschine: Laborzentrifuge  
Machine: Laboratory Centrifuge  
Désignation de la machine: Centrifugeuse de laboratoire

Maschinentyp : 1 - 6  
Type:  
Type de la machine:

Bestell Nr. : 10105, 10106, 10107  
Part No.:  
Réf. usine:

Normen: EN 61010-2-020  
Standards: EN 61000-3-2 ; EN 61000-3-3  
Normes : EN 61326

**Sigma Laborzentrifugen**

An der Unteren Söse 50  
D-37520 Osterode



01.02.2002

Geschäftsführer  
Managing Director  
Directeur Gérant

.....  
Fabr. Nr. Serial No. Numéro de fabrication

Konformitätserklärung dreisprachig 1-6 20020201.DOC



## General Information

- 1.1 Technical data
- 1.2 Suitable accessories
- 1.3 Scope of supply
- 1.4 Standards and regulations
- 1.5 Safety instructions
- 1.6 Symbol table

## Description of the Centrifuge

- 2.1 General outlay
- 2.2 Construction and constructive safety measures
- 2.3 Drive
- 2.4 Operation and display
- 2.5 Electronics
- 2.6 Safety devices
  - 2.6.1 Lid lock, cover closing device
  - 2.6.2 Standstill monitoring
  - 2.6.3 System check
  - 2.6.4 Ground wire check

## Installation and Start-up

- 3.1 Unpacking of the centrifuge
  - 3.1.1 Transport safety device
- 3.2 Installation
  - 3.2.1 Site
  - 3.2.2 Connection
  - 3.2.3 Fuses / emergency circuit breaker on site
- 3.3 Installation of rotors and accessories
- 3.4 Initial start-up
  - 3.4.1 Switching on of the centrifuge
  - 3.4.2 Opening lid
  - 3.4.3 Installation of a rotor

## Operating Elements

- 4.1 Operating panel
  - 4.1.1 Start-key
  - 4.1.2 Stop-key
  - 4.1.3 Lid-key
  - 4.1.4 Knobs

- 4.2 Displays
- 4.2.1 Speed/RCF (Relative centrifugal force)
- 4.2.1.1 Speed
- 4.2.1.2 Relative centrifugal force (RCF)
- 4.2.2 Time
- 4.2.3 Standard run mode
- 4.2.3.1 Continuous run mode
- 4.2.3.2 Short-time operation
- 4.2.3.2.1 Short-run 1
- 4.2.3.2.2 Short-run 2

## Notes for Centrifugation

- 5.1 Practical notes for centrifugation
- 5.2 Forbidden centrifuging operations

## Care and Maintenance

- 6.1 Care and cleaning of centrifuge
- 6.2 Care and cleaning of accessories
- 6.3 Glass breakage
- 6.4 Sterilization and disinfection of rotor chamber and accessories
- 6.4.1 Autoclaving
- 6.5 Checks by operator

## Appendix

- 7.1 Mathematical relations
- 7.1.1 Relative Centrifugal Force (RCF)
- 7.1.2 Density
- 7.2 Error correction
- 7.2.1 Centrifuge cannot be started
- 7.2.2 Centrifuge decelerates during operation
- 7.2.3 Lid cannot be opened/closed
- 7.2.4 Emergency lid release
- 7.2.5 Problems with the centrifuge?
- 7.3 Error mode
- 7.3.1 Error codes
- 7.4 Diagram speed/gravitational field
- 7.5 Declaration of decontamination/Return declaration
- 7.6 Leaflet



<b>1.1 Technical Data</b>	
Manufacturer:	S I G M A Laborzentrifugen GmbH 37520 Osterode
Type:	1-6
Electr. connection: Protection class:	see nameplate I
Power consumption (kVA): Rated power (kW): Max. current (A):	0,37 0,22 1,5 (230 V/50 Hz) respectively 3,0 (120 V/60 Hz)
Power data:	
Max. speed (rpm): Max. capacity (ml): Max. gravitational field (x g): Max. kin. energy (Nm):	5 650 90 3 030 980
Further parameters	
Time range:	0 - 30 min/continuous run/ short-time operation
Dimensions:	
Depth (mm): Width (mm): Height (mm): Weight (kg): EMC (acc. to EN 55011): Noise level (dBA):	320 240 245 13 Class B < 58
Notes of user:	
Serial number:	.....
Supply date:	.....
Inventory number:	.....
Location:	.....
Responsibility:	.....

The figures are valid for an ambient temperature of 23 °C +/- 2 °C and nominal voltage +/- 5 %.  
(Allowable ambient temperature +4 °C - +40 °C; max. humidity 80 %.)  
Subject to technical alterations.



## 1.2 Accessories Suitable for SIGMA 1-6

Part No.	Description	Max. speed (rpm)	Max. gravitational field (x g)
12066	Angle rotor 6 x 15 ml for round or conical tubes, max. Ø 17 x 120 mm, e.g. 15015, 15020, 15023, 15024, Monovettes or culture tubes 15 ml (Nunc, Corning, Falcon or Greiner) e.g. 15115, max. radius 8.5 cm, min. radius 2 cm (with 100 mm tube length), angle 30°, incl. buckets 13011	5 650	3 034

### Adaptors, plastic vessels and glass tubes

---

13070	Adapter for 1 round bottom tube, max. Ø 13.5/17 x 70-82 mm, e.g. Vacutainer, polypropylene
13071	Adapter for 1 round bottom tube approx. 5 ml, max. Ø 12.8 x 75-90 mm, e.g. 15060 (RIA) or hemolyse tubes, polypropylene
13072	Adapter for 1 round bottom tube 4.5-6 ml, max. Ø 12.3 x 90-105 mm, e.g. 15007, 15027, polypropylene
15060	Polystyrene tube 5 ml (RIA-tube), Ø 12 x 75 mm, suitable for 13071
15007	Centrifuge glass tube 6 ml, Ø 12 x 100 mm, suitable for 13072
15027	ditto, graduated, 0 - 5.5 ml in steps of 0.1 ml
15015	Centrifuge glass tube 10-12 ml, Ø 16 x 100 mm, suitable for 12066
15024	ditto, graduated, 0 - 10 ml in steps of 0.1 ml
15020	Polystyrene tube 14 ml, Ø 17 x 100 mm, suitable for 12066
15021	Polypropylene stopper for 15020, 15023
15023	Polypropylene tube 14 ml, Ø 17 x 100 mm, suitable for 12066

Part No.	Description	Max. speed (rpm)	Max. gravitational field (x g)
15115	Culture tube with screw cap 15 ml, pointed bottom, suitable for 12066, polypropylene		
90020	Angle rotor for 6 sterilin tubes 30 ml, graduated up to 20 ml, with skirt, incl. cap, max. Ø 25/31 x 65 - 95 mm, polypropylene, see <a href="http://www.bibby-sterilin.co.uk">www.bibby-sterilin.co.uk</a> , no. 03008	5 650	3 030

Further accessories are available on request.

## Maximum speed for tubes

Some tubes, e.g. centrifuge glass tubes, microtubes, culture tubes, polyflor tubes and especially high volume tubes can be used in our rotors, buckets and adapters at higher speeds than their breaking limit. We recommend to always fill up the tubes and to follow the recommendations of the manufacturer.

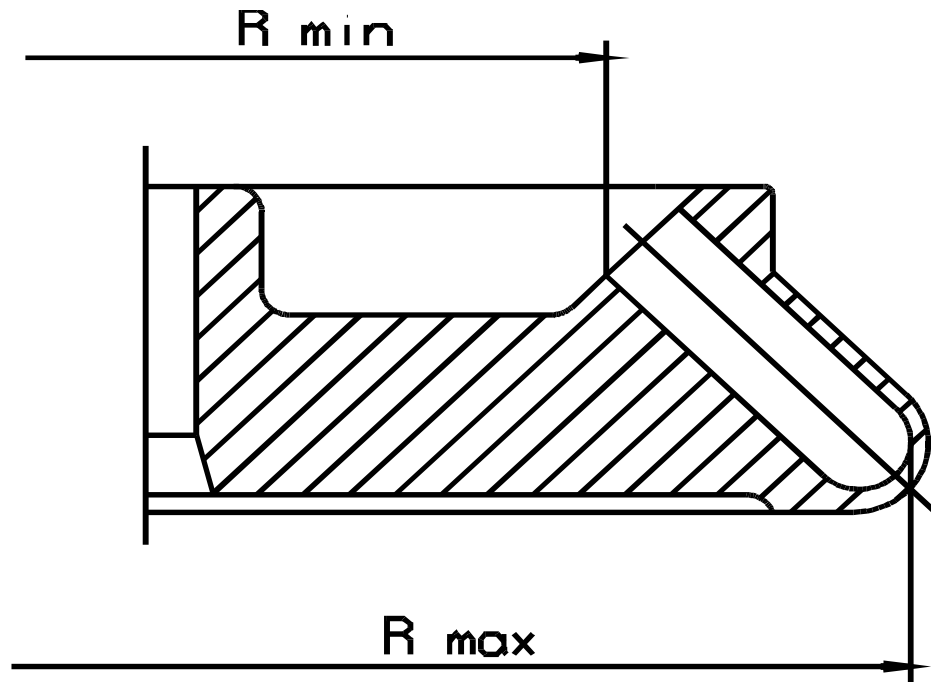



### 1.3 Scope of Supply

The following belongs to the centrifuge:

Connection cable	Part No. 269 010
Rotor wrench	Part No. 930 050
20 ml slushing oil	Part No. 70104

Documentation:

Operating Manual  
"Rotor and Accessories, Operation and Use"  
EU-Statement of Conformity  
Equipment Decontamination Certificate

Accessories according to your order, our order confirmation and our delivery note.

Rotor Part No.	Rotor No.
.....	.....
.....	.....
.....	.....
.....	.....
.....	.....
.....	.....
.....	.....

### 1.4 Standards and Regulations

Please refer to the enclosed EU-Statement of Conformity.

## 1.5 Safety Instructions











According to the German trade association regulation BGR500 chapter 2.11 part 3 the owner of the instrument is advised to take care of the following points:

1. According to BGR500 the owner has to provide operating instructions based on those of the manufacturer and to inform the employees accordingly.
2. For safety reasons these operating instructions must clearly state that the stamped max. speed of the used rotor and the max. allowable filling quantity must not be exceeded.
3. If the density of the material exceeds  $1.2 \text{ g/cm}^3$ , the max. speed of the centrifuge must be reduced (see formula chapter 7.1.2).
4. Operation of the centrifuge in hazardous locations is not allowed.
5. During operation the centrifuge must not be moved. Leaning against or resting on the centrifuge is not allowed.
6. Do not spin explosive or highly inflammable materials.
7. Substances which could damage the material of the centrifuge, the rotors or the buckets anyhow must not be centrifuged or only under consideration of special safety measures. Infectious, toxic, pathogene or radioactive substances must be centrifuged in certified rotors only.
8. Keep a clearance of at least 30 cm around the centrifuge. Dangerous materials of any kind must not be put down or stored in that area.
9. Attention!  
Defective lid relieving devices could cause the centrifuge lid to fall down (contact Service). Risk of bruising!



## 1.6 Symbol Table

International symbols used for the centrifuge:

Symbol	Title
	Gefährliche elektrische Spannung Dangerous voltage Courant haute tension
	Achtung, Bedienungsanleitung beachten Attention, consult accompanying documents Attention, consulter les documents joints
	Ein (Netzverbindung) On (Power) Marche (mise sous tension)
	Aus (Netzverbindung) Off (Power) Arrêt (mise hors tension)
	Schutzleiteranschluß Protective earth (ground) Liaison à la terre
	Erde Earth (ground) Terre
	Netzstecker ziehen Unplug mains plug Tirer la fiche de prise
	Vorsicht Quetschgefahr Caution! Risk of bruising Attention! Danger de blessure
	Drehrichtungspfeil Arrow direction of rotation Flèche sens de rotation
	Heiße Oberfläche Hot surface Surface chaude

## 2.1 General Outlay

The new generation of SIGMA laboratory centrifuges is equipped with newest state-of-the-art electronics and is driven by brushless, silent and long-life asynchronous motors.

The problem of carbon brush change is no longer existent and as there is no carbon dust pollution, operation in clean rooms is possible if the appropriate accessories are used.

## 2.2 Construction and Constructive Safety Measures

The centrifuge is built into a solid steel housing. The centrifuge lid is also made of solid steel. From the back, the lid is secured by solid hinges and at the front by two separate cover locks.

## 2.3 Drive

The drive motor is a well dimensioned asynchronous motor.

## 2.4 Operation and Display

The graphical LCD display is hermetically sealed, operation is executed via two knobs. Any operating status is indicated.

## 2.5 Electronics

The electronics controlled by a microprocessor allows extensive adaptations of the centrifuge to the different tasks. The following parameters can be set:

- Speed
- RCF
- Time in steps of 1 min (max. 30 min)
- Continuous operation
- Short-time operation

## 2.6 Safety Devices

Apart from the passive safety devices due to the instrument's mechanical design there are the following active precautions for your safety:

### 2.6.1 Lid Lock, Cover Closing Device

The centrifuge can only be started when the lid is correctly closed. The cover locks must close. The lid can only be opened when the rotor has stopped. If the lid is opened by the emergency release during operation, the centrifuge will immediately switch off and decelerate brakeless. If the lid is open, the drive is completely separated from the mains supply, that means starting of the centrifuge is impossible (refer to point 7.2.4 "Emergency lid release").

### 2.6.2 Standstill Monitoring

Opening of the centrifuge lid may only be possible, if the rotor is at standstill. This standstill is checked by the microprocessor.

### 2.6.3 System Check

An internal system check monitors data transmission and the sensor signals with regard to plausibility. In case of a malfunction an error message is displayed under a number in the time area.

### 2.6.4 Ground Wire Check

For ground wire check there is a ground screw at the rear panel of the centrifuge. A ground wire check can be carried out using an appropriate measuring instrument.

### 3.1 Unpacking of the Centrifuge

Open cardboard. Take out the box containing accessories. Remove upper foam cushions. Lift centrifuge upwards. When lifting or carrying the centrifuge please always reach under the instrument from the side.

Please keep case for possible transport of centrifuge later.

#### 3.1.1 Transport Safety Device

The SIGMA 1-6 has no transport safety device.

## 3.2 Installation

### 3.2.1 Site

All energy consumed by the centrifuge is converted into heat and emitted into the ambient air. Therefore, sufficient ventilation is important. As the air-ducts in the unit must be open, keep a clearance of at least 30 cm around the centrifuge. Also, the centrifuge shouldn't be positioned near radiators and should not be directly exposed to sunshine.

The table should have a solid, even top.

For normal operation the ambient temperature should not fall below 10 °C and not exceed 35 °C. The max. humidity of air is 80 %. During transport from cold to warmer places water will condensate inside the centrifuge. It is important that there is enough time for drying before the centrifuge can be started again.

### 3.2.2 Connection

The operating voltage on the name plate must correspond to the local supply voltage!

SIGMA laboratory centrifuges are units of safety class I, DIN VDE 0700, and include a three wire power cord 2,5 m long with shockproof right angle plug.

At the back, next to the mains supply, there is an additional ground wire connection where a separate ground wire can firmly be connected to ground any non-hazardous leakage current. The leakage current is harmless but secondary effects would occur.

### 3.2.3 Fuses / Emergency Circuit Breaker on Site

The centrifuges must be protected typically with at least 16 A slow acting fuses.

An emergency circuit breaker to cut the power to the centrifuge in the event of a malfunction is required on site. This switch should be located away from the centrifuge, preferably outside the room where the centrifuge is used or at the exit of this room.

### 3.3 Installation of Rotors and Accessories



1. Open centrifuge lid by pressing the Lid-key.
2. Unscrew rotor tie-down screw from motor shaft (anticlockwise).
3. Lower the rotor straight down onto the motor shaft.
4. Tighten the tie-down screw (clockwise) with the rotor wrench with approx. 5 Nm.

In the event of frequent use the tie-down screw must be loosened by some turns and fastened again. **This should be done once a day or after approx. 20 cycles.** This ensures a proper connection between rotor and shaft (please refer to chapter 6.2 "Care and cleaning of accessories" as well).

5. Use only appropriate vessels for the rotor (please refer to chapter 1.2 "Suitable accessories" as well).
6. Fill vessels external to the centrifuge.
7. Put or screw on covers of vessels.
8. Opposite places of the rotors must always be loaded with same accessories and same filling.
9. In angle rotors the plastic vessels must always be totally filled to avoid cracks of vessels and leakages or loosening of the caps in case of partial filling.

**Attention, follow the special comments of chapter 1.5.**

10. **Attention:** The centrifuge will absorb smaller differences in weight when loading the rotors. But it is recommended to balance the vessels as accurately as possible in order to ensure a run with minimal vibrations.
11. Don't fix the rotor screw without a rotor. Otherwise you'll destroy the shaft.

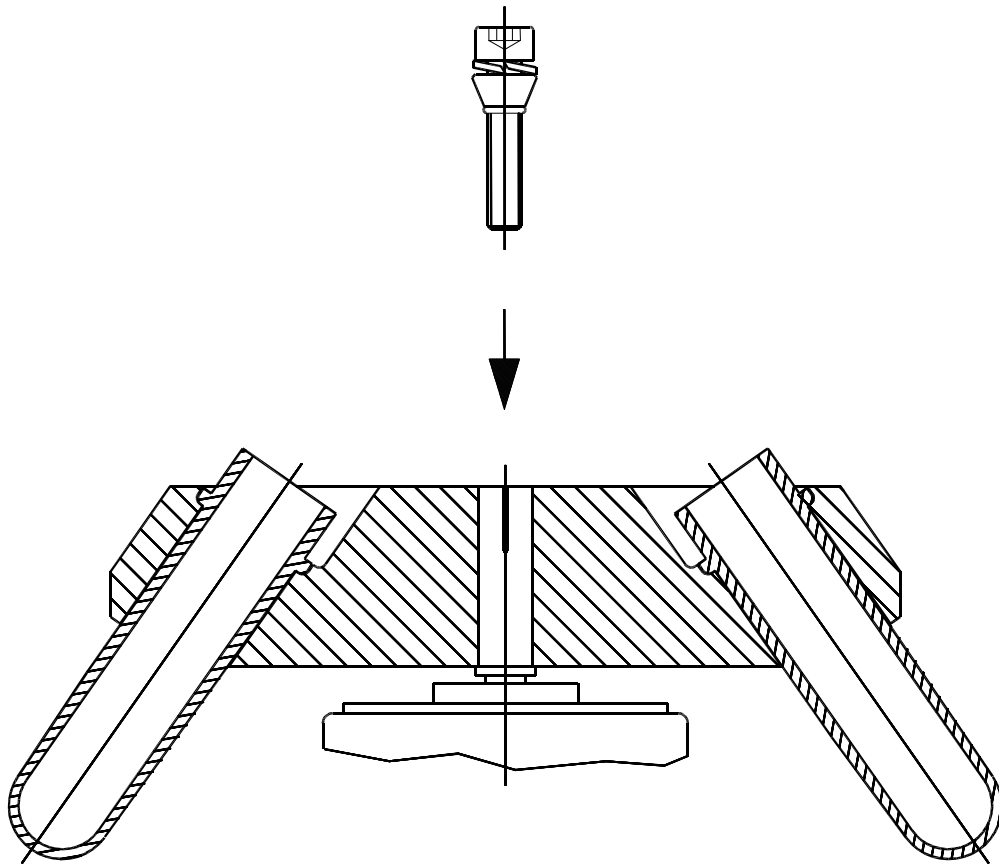

## 3.4 Initial Start-Up

Attention!

Before initial start-up please take care that your centrifuge is orderly installed (refer to chapter 3.2 "Installation").

### 3.4.1 Switching on of the Centrifuge

Press mains switch (right side panel).

- The centrifuge display is illuminated.

### 3.4.2 Opening Lid

Press the Lid-key.



- The lid opens.

### 3.4.3 Installation of a Rotor

Put a rotor onto the shaft and fasten it by screwing the rotor tie-down screw clockwise onto the drive shaft. Please use the supplied rotor wrench (refer to chapter 3.3 "Insertion of rotor and accessories").



## 4.1 Operating Panel

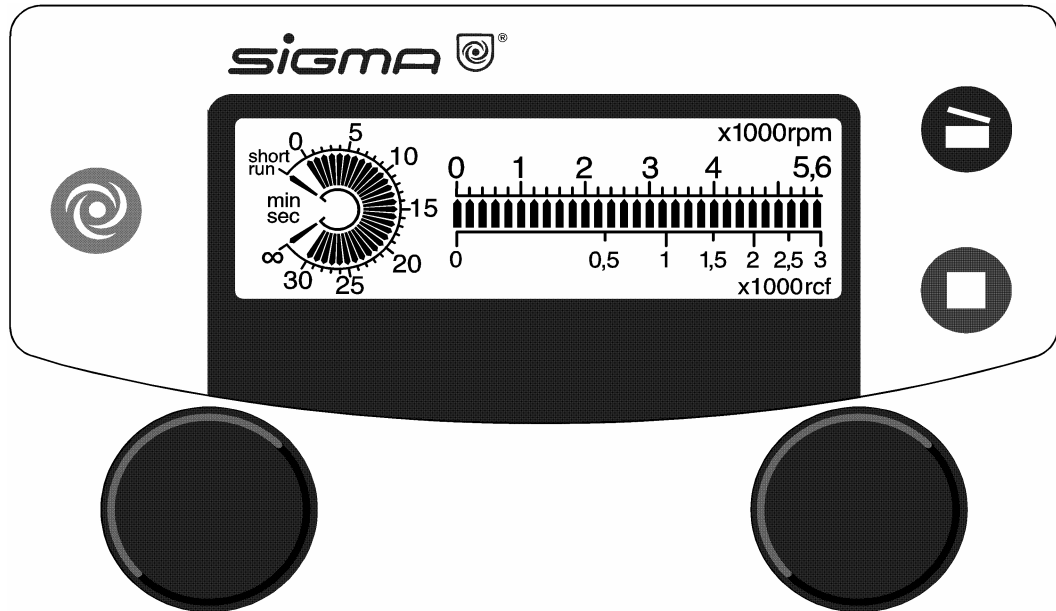

The centrifuge is operated via the operating panel. Keys can be pressed when their LED is on.

When power is applied, all LEDs and the display are illuminated for a short time.

#### 4.1.1 Start-key



This key can be used for the following:

- starting centrifuge operation,
- terminating a previously started deceleration process and restarting the centrifuge,
- shifting to short-run (refer to chapters 4.2.3.2.1, 4.2.3.2.2).
- saving a program. The parameters speed and time preselection can be locked, thereafter a change is impossible. Starting and stopping the centrifuge and opening of the lid is always possible.  
Open centrifuge lid. Press the start-key 3 x and hold for approx. 2 seconds when pressing for the third time. A flashing bar appears in the time and/or speed panel. Cancellation of this function occurs in the same way.

The centrifuge can be started when

- the lid is closed,
- the Start-key is illuminated.

#### 4.1.2 Stop-key



This key can be used

- to early terminate the run.

The centrifuge decelerates to a complete stop. Deceleration can be terminated by pressing the Start-key again and the centrifuge can be restarted.

#### 4.1.3 Lid-key



This key is used to open the lid.

This can only be executed if

- the centrifuge has come to a complete stop,
- the Lid-key is illuminated.

#### 4.1.4 Knobs

The parameters are selected by turning the knobs.

The time values are changed by turning the left knob, the right knob is used for changing the speed/RCF values.

## 4.2 Displays

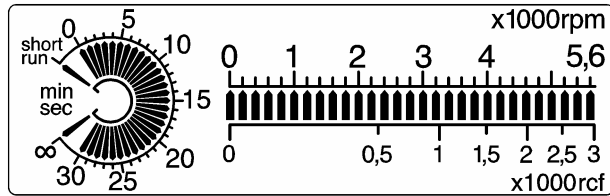

The display consists of two areas:  
The left area is the time display, the right one the speed/RCF display.

### 4.2.1 Speed/RCF (Relative Centrifugal Force)

Rotor dimensions and speed determine the RCF value. Entry of one value automatically determines the other one.

### 4.2.1.1 Speed

The upper scale of the right display area indicates rpm x 1000. This value can be set by turning the right knob.

After entry of a speed a single bar indicates the set speed.

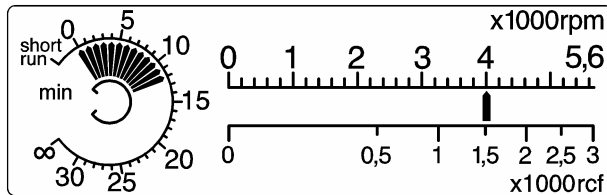

During the run the actual speed is indicated by a sequence of bars.

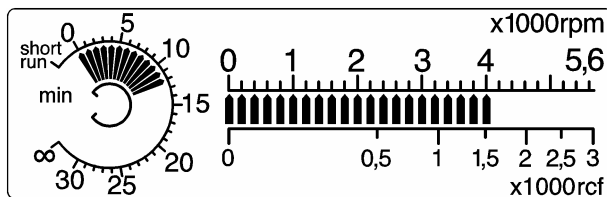

The speed value can be changed during the run by turning the right knob.

To avoid inadvertent changes a software block must be overcome when changing the speed value during a run. Turn the right knob strongly in one direction. The desired speed value can then be set.

If during the run the speed is set below the actual speed, the new set speed is indicated by a flashing bar and the drive is decelerating to the new value.

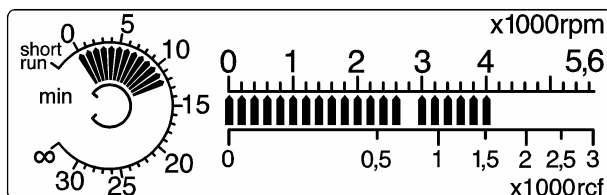

### 4.2.1.2 Relative Centrifugal Force (RCF)

The relative centrifugal force (RCF) is the acceleration which the sample is exposed to.

The lower scale of the right area indicates the RCF value x 1000. This can be set by turning the right knob.

After entry of a RCF value a single bar indicates the set speed.

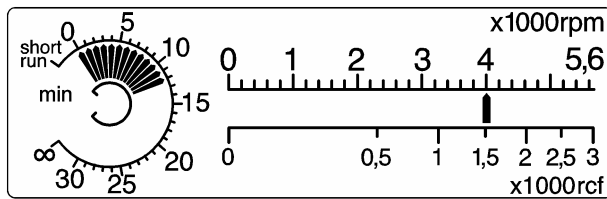

A sequence of bars indicates the actual RCF value during a run.

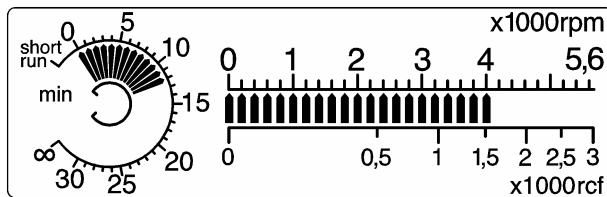

The RCF value can be changed during a run by turning the right knob.

To avoid inadvertent changes a software block must be overcome when changing the RCF value during a run. Turn the right knob strongly in one direction. The desired RCF value can then be set.

If during the run the RCF value is set below the actual value, the new set RCF value is indicated by a flashing bar.

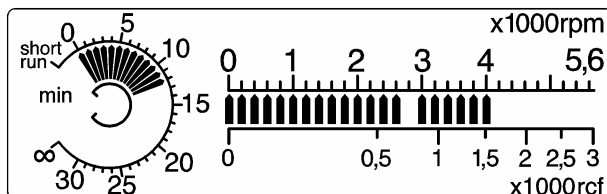

## 4.2.2 Time

Depending on the run mode this area indicates the total set time, the remaining run time or the elapsed time.

The time value as well as different run modes can be set by turning the left knob, even during centrifugation.

To avoid inadvertent changes a software block must be overcome when changing the time during a run. Turn the left knob strongly in one direction. The desired time can then be set.

If the time is changed during centrifugation, the total newly entered period is run. the time elapsed before is not considered.

### 4.2.3 Standard Run Mode

For the standard run mode the time is set in minutes by turning the left knob ("min" is displayed).

This total run time (max. 30 minutes) is displayed by a sequence of bars before starting the centrifuge.

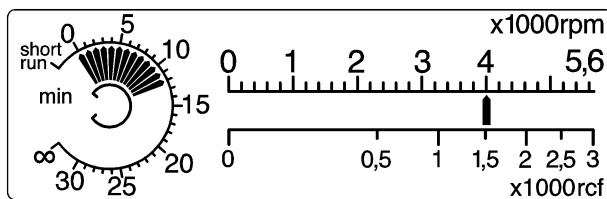

During centrifugation this time is counted down, the sequence of bars indicates the remaining run time. The set time is indicated by one single bar.

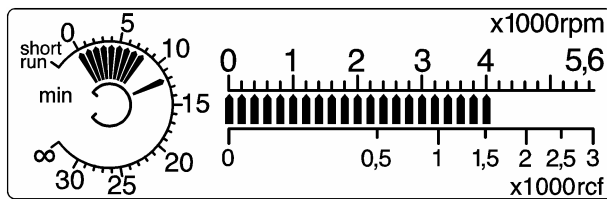

The centrifuge run can be early terminated by pressing the Stop-key. The set time and the remaining run time remain on the display.

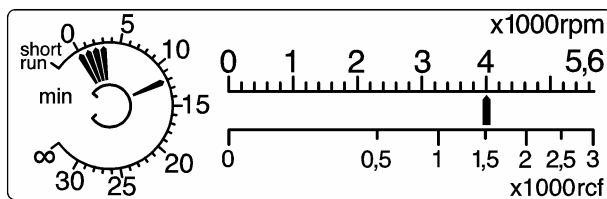



### 4.2.3.1 Continuous Run Mode

During continuous run the centrifuge accelerates up to the set speed and must be terminated manually.

Select  $\infty$  turning the left knob clockwise and press the Start-key to activate the continuous run.

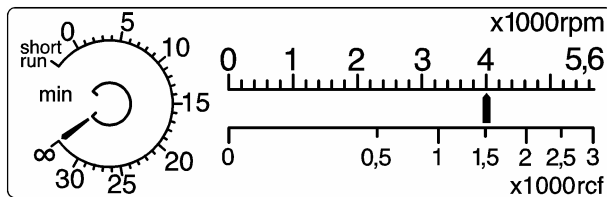

Unlike the standard run mode the minutes are counted up. A sequence of bars indicates the elapsed run time. One single bar at  $\infty$  is indicating the continuous run mode.

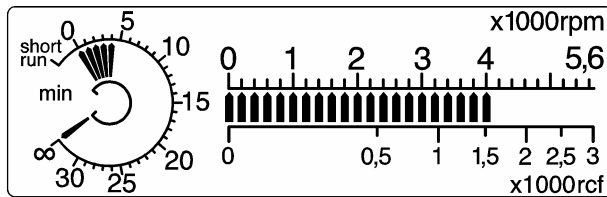

After 30 minutes the remaining run time is no longer displayed but the run continues.

The continuous run is terminated by pressing the Stop-key and the centrifuge decelerates to a complete stop. The elapsed time is displayed in minutes.

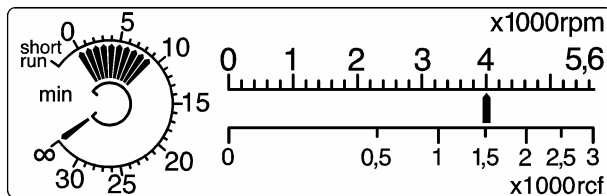

The continuous run mode can be left by selecting a set value as well.

## 4.2.3.2 Short-Time Operation

There are two options:

### 4.2.3.2.1 Short-Run 1

Press the Start-key for the whole short-run. The centrifuge accelerates to the maximum speed (5600 rpm). After release of the Start-key the centrifuge decelerates to standstill.

During short-run the time is counted up in seconds, "sec" is displayed.

A sequence of bars is indicating the elapsed run time. One single bar at "short run" indicates that short-time operation had been selected. A flashing bar indicates the maximum speed.

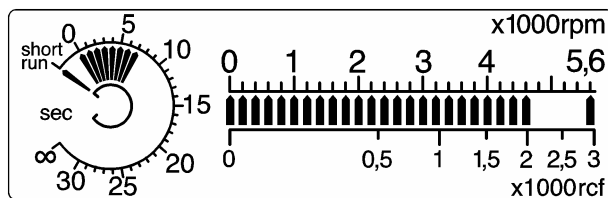

After termination of the short-run the elapsed run time in seconds remains on the display.

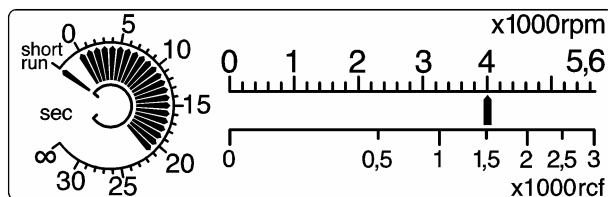

### 4.2.3.2.2 Short-Run 2

During this short-run the centrifuge is running max. 30 seconds and accelerates to the set speed.

Select "short run" by turning the left knob and press the Start-key.

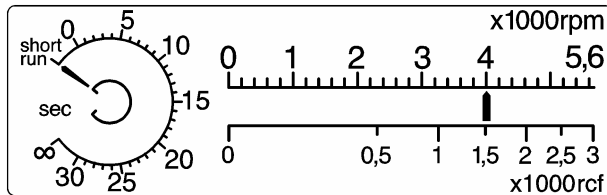

During the short-run the time is counted up in seconds. A sequence of bars indicates the elapsed run time. One single bar at "short run" indicates that short-time operation had been selected.

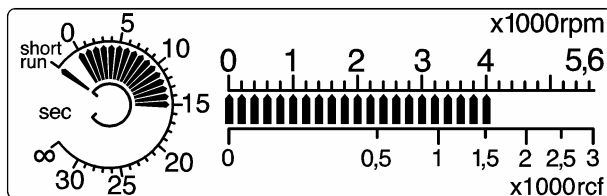

After 30 seconds the centrifuge decelerates to a complete stop.

The short-run can be early terminated by pressing the Stop-key. The centrifuge decelerates to standstill. The elapsed run time in seconds remains on the display.

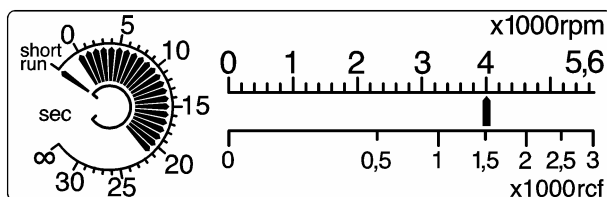

The "short run" can be left by selecting a set value as well.

## 5.1 Practical Notes for Centrifugation

1. Locate centrifuge horizontally on a level surface.
2. Ensure safe location.
3. Keep at least 30 cm free space around the centrifuge.
4. Provide for sufficient ventilation.
5. Tighten rotor firmly onto motor shaft.
6. Avoid imbalance.
7. Load opposite places with same accessories.
8. Centrifugation with low capacity:

The vessels should be placed symmetrically so that the rotor is loaded evenly. Loading e.g. only one position is not allowed.

9. Load vessels outside the centrifuge.
10. Fill vessels carefully to same weight. Imbalances would result in increased wear of bearings.
11. Use perfect accessories only.
12. Avoid corrosion to accessories by careful maintenance.
13. Spin infectious material in sealed rotors and buckets only.
14. Do not spin explosive or highly inflammable materials.
15. When centrifuging substances with a density  $> 1,2 \text{ g/cm}^3$  the allowable max. speed must be reduced (refer to chapter 7.1.2 "Density").

## 5.2 Forbidden Centrifuging Operations

1. Operation of not carefully installed centrifuge.
2. Operation without front or back panels.
3. Operation by non authorized personnel.
4. Operation with rotor not installed properly (refer to chapter 3.3).
5. Operation with overloaded rotors.

The load for a rotor is limited by its design and the max. speed (see rotor/bucket engraving) and must not be exceeded. The rotors are intended for liquids of max. homogeneous density of 1.2 g/cm<sup>3</sup> if centrifuged at max. speed. If liquids of higher density are used, the speed must be reduced accordingly (refer to chapter 7.1 "Mathematical relations").

6. Operation with rotors and adapters showing corrosion or other defects.
7. Operation of very corrosive substances which can cause damages to material and affect mechanical strength of rotors and adapters.
8. Operation of rotors and accessories not allowed by the manufacturer. The use of poor commodity goods is not recommended. At high speeds breaking glass or bursting vessels can cause dangerous imbalances.
9. Operation in hazardous locations.
10. Operation with vessels of improper size.
11. Centrifugation of improper material.
12. Operation with partially filled plastic tubes in high-speed angle rotors.
13. Lifting or moving of the centrifuge during operation. Leaning against or resting on the centrifuge is not allowed.
14. Do not place potential dangerous material - e.g. glass vessels containing liquids - near the centrifuge.
15. Attention: Do not open cover and/or reach into rotor chamber unless the rotor is at standstill. Never attempt to override the lid interlock system while the rotor is spinning.
16. Such materials are prohibited which chemically interact vigorously.
17. Do not spin explosive or inflammable materials.

18. Substances which could damage the material of the centrifuge, the rotors or the adapters must not be centrifuged. Infectious, toxic, pathogene or radioactive substances must be centrifuged in certified rotors and vessels only and all necessary safety precautions are taken.

## 6.1 Care and Cleaning of Centrifuge

Please use water-soluble, mild detergents for cleaning. Avoid corroding and aggressive substances. Do not use alkaline solutions or solvents or agents with abrasive particles. Before using detergents or decontamination agents which had not been recommended by us, the user has to contact us to make sure that such procedure would not damage the centrifuge.

Remove product particles from the rotor chamber using a cloth or paper towel. It is recommended to open the cover when the centrifuge is not in use so that moisture can evaporate. Increased wear of the motor bearings will thus be avoided. **If there is the risk of toxic, radioactive or pathogene contamination, special safety measures must be kept.**

## 6.2 Care and Cleaning of Accessories

For care of accessories special safety measures must be considered as these are measures ensuring operational safety at the same time.

Chemical reactions as well as stress-corrosion (combination of oscillating pressure and chemical reaction) can affect or destroy the metals. Hardly detectable cracks on the surface expand and weaken the material without visible signs. When detecting a visible damage of the surface, a crack, a mark or any other change, also corrosion, the part (rotor, etc.) must be replaced immediately.

In order to avoid corrosion, rotor incl. tie-down screw and cover seal and adapters must be cleaned and greased regularly with the supplied slushing oil (Sigma part no.: 70104 for 20 ml slushing oil). Before using detergents or decontamination agents which had not been recommended by us, the user has to contact us to make sure that such procedure would not damage the centrifuge. The rotor tie-down screw must be greased using grease (Sigma part no.: 70284).

Cleaning of accessories should be done outside of the centrifuge once a week or preferably after every use. Adapters should be removed. After this the parts should be dried with a soft cloth or, alternatively, in a drying chamber at approx. 50 °C. **If there is the risk of toxic, radioactive or pathogene contamination, special safety measures must be kept.**

Especially aluminium parts are extremely corrosive. A neutral cleaning detergent with a pH-value between 6 and 8 should be used for such parts. Alkaline agents exceeding pH 8 must be avoided. Especially aluminium parts must be greased regularly with slushing oil. This procedure essentially increases life time and reduces corrosion.

Careful maintenance increases life time and avoids premature failure of the rotor. Corrosion or resultant damages which are caused by insufficient care do not constitute a warranty claim.

### 6.3 Glass Breakage

In case of glass breakage all glass particles must be carefully removed. Rubber inserts have to be cleaned carefully and possibly be replaced. If a problem has occurred, the following has to be considered:

Glass particles in the rubber cushion will cause glass breakage again.

Glass particles in the centrifuge chamber will cause metal abrasion due to the strong air circulation. This dust will not only pollute the centrifuge chamber, the rotor and the material to be centrifuged but also damage the surfaces of the accessories, the rotors and the centrifuge chamber.

In order to totally remove the glass particles and the metal dust from the rotor chamber, it is advisable to grease the upper part of the centrifuge chamber with e.g. Vaseline. Then the rotor should rotate for some minutes at a moderate speed. The glass and metal particles will now collect at the greased part and can easily be removed with a cloth together with the grease. If necessary repeat this procedure.

### 6.4 Sterilization and Disinfection of Rotor Chamber and Accessories

All usual disinfectants like eg. Sagrotan, Buraton or Terralin (to obtain at chemist's shops) can be used. The centrifuges and the accessories consist of different materials. A possible incompatibility must be considered. Before using detergents or decontamination agents which had not been recommended by us, the user has to contact us to make sure that such procedure would not damage the centrifuge. For sterilization by steam resistance to temperature of the individual material must be checked (refer to point 6.4.1 "Autoclaving"). Please contact your laboratory safety officer regarding proper methods to use. **If dangerous materials are used, the centrifuge and the accessories must be disinfected.**

Principally we want to point out that for centrifuging of e.g. infectious material certified and hermetically sealed accessories have to be used in order to avoid that the centrifuge is contaminated.



## 6.4.1 Autoclaving

The life of the accessories essentially depends on the frequency of autoclaving and use. When the parts are showing changes in colour or structure or in the event of leaks etc., the accessories have to be replaced.

During autoclaving the caps of the tubes must not be screwed on to avoid deformation of the tubes. It can not be excluded that plastic parts, e.g. lids or carriers, would deform during autoclaving.

### Autoclaving:

Accessories	max. temp. °C	min. time min	max. time min	max. cycles
Glass tubes	134-138	3	5	-
Polycarbonate tubes	115-118	30	40	20
Polypropylene tubes	115-118	30	40	30
Teflon tubes	134-138	3	5	100
Aluminium rotors	134-138	3	5	-
Polypropylene rotor 12034	115-118	30	40	20
Polypropylene rotor 12124	115-118	30	40	20
Polycarbonate/Polyallomer lids for angle rotors	115-118	30	40	20
Polysulfone lids for angle rotors	134-138	3	5	100
Aluminium buckets	134-138	3	5	-
Polycarbonate caps for buckets	115-118	30	40	50
Polypropylene caps for buckets	115-118	30	40	50
Polysulfone caps for buckets	134-138	3	5	100
Rubber adapters	115-118	30	40	-
Rubber cushions	115-118	30	40	-
Round carriers for 13104/ 13117, Polypropylene	115-118	30	40	-
ditto, Polyallomer and Polycarbonate	115-118	30	40	-
Round carriers for 13350/ 13550, Polypropylene	115-118	30	40	-
Rectangular carriers, Polypropylene	115-118	30	40	-
ditto, Polyallomer and Polycarbonate	115-118	30	40	-

## 6.5 Checks by Operator

The operator has to ensure that no important part of the centrifuge is damaged. This especially refers to:

1. Motor suspension
2. Concentricity of the motor shaft
3. Fastening of the trunnions in the rotor
4. Rotors and accessories have a limited life. For safety reasons a regular check is recommended after 50.000 cycles. Any changes like e.g. corrosion, cracks, material abrasion etc. require special attention.
5. Screw connections have to be tight.

Furthermore, the earth wire must be checked regularly.

## 7.1 Mathematical Relations

### 7.1.1 Relative Centrifugal Force (RCF)

The parameters speed, RCF and the diameter of the rotor are interrelated via the following formula:

$$\text{RCF} = 11,18 \times 10^{-6} \times r \times n^2$$

If two values are given, the third value is determined by the equation. If the speed or the rotation radius is changed, the resulting RCF will be recalculated. If the RCF is altered, the speed under consideration of the radius is adapted accordingly.

r = radius in cm  
n = speed in rpm  
RCF without dimension

### 7.1.2 Density

If the density of the liquid is higher than 1.2 g/cm<sup>3</sup>, the allowed maximum speed of the centrifuge is calculated according to the following formula:

$$n = n_{\text{max}} \times \sqrt{(1,2 / \text{Rho})}$$

Rho = density in g/cm<sup>3</sup>

## 7.2 Error Correction

Most of the errors can be reset by power off/on. In the event of a short power failure during a run, this run is interrupted and can be continued by pressing the Start-key.

### **No indication on the display:**

### **Actions:**

- No power in the socket?
  - Power cord plugged in and line voltage present?
  - Input fuse ok?
  - Power switch on?
  - Lid closed?
- Check fuse in mains supply.
  - Plug in power cord correctly.
  - Replace input fuse (see nameplate for rating).
  - Switch on power.
  - Close lid (please refer to chapter 7.2.3 "Lid cannot be opened/closed.").

### 7.2.1 Centrifuge cannot be Started

- Start-key LED illuminated:
  - Lid-key LED flashing:
- Power off/on. If error occurs again, call service.
  - Open and close the lid again. If error occurs again although both locks engaged, call service.

### 7.2.2 Centrifuge Decelerates during Operation

- Centrifuge displays an error 1 to 11 after power on.
- Power off/on. If error occurs again, call service (please refer to chapter 7.3.1 "Error codes").

### 7.2.3 Lid cannot be Opened/Closed

- When first trying to open the lid the locks are not released. The Lid-key LED is flashing. Open and close lid again.

## 7.2.4 Emergency Lid Release

In the event of e.g. a power supply failure it is possible to manually open the lid. At the bottom panel there are two stoppers which can be removed e.g. with a screw driver. The lid can be released by pulling the visible string.

### **Attention!**

**The lid may only be unlocked and opened when the rotor is at standstill.**

## 7.2.5 Problems with the Centrifuge?

Please contact your supplier for support or in the event of malfunctions and for supply of spare parts.

## 7.3 Error Mode

In the error modes the Start-, Stop- and Lid-keys and the bars in the speed display are flashing. The error codes are displayed on the time display.

### 7.3.1 Error Codes

Error no.	Kind of error	Actions
1	Tacho signal disturbed	• Power off/on
4	Lid does not open after pressing the Lid-key	• Power off/on • Emergency lid release
2, 3, 5 - 11	Internal fault	• Power off/on

Should it not be possible to repair the failure, please contact Service!

## 7.4 Speed-RCF-Diagram

An additional help is the enclosed Speed-RCF-Diagram.

## 7.5 Declaration of Decontamination / Return Declaration

The following declarations serve for keeping safety and health of our employees. Fill in the forms and attach them when returning centrifuges, accessories and spare parts. Please understand that we cannot carry out any work before we have the declarations. (We recommend to make **several copies of this page.**)



!!! Attention – This form must be glued on outside of the box !!!

## Return declaration

	YES	NO
Decontamination declaration inside :		
Unit / component contaminated :		
Unit / component unused (new) :		

!!! Attention – This form must be glued on outside of the box !!!



Please make some copies before removing this page.







**Declaration of Decontamination of Centrifuges, Accessories and Spare Parts**

This declaration may only be filled in and signed by authorised staff.



Repair Order dtd. : \_\_\_\_\_

Order No. : \_\_\_\_\_

Type of unit : \_\_\_\_\_ Serial No. : \_\_\_\_\_

Type of unit : \_\_\_\_\_ Serial No. : \_\_\_\_\_

Type of unit : \_\_\_\_\_ Serial No. : \_\_\_\_\_

Type of unit : \_\_\_\_\_ Serial No. : \_\_\_\_\_

Accessories : \_\_\_\_\_

Is the equipment free from harmful substances ? YES  NO

If not, which substances have come into contact with the equipment?

Name of the substances : \_\_\_\_\_

Remarks (e.g to be touched with gloves only) ; \_\_\_\_\_

General characteristics of the substances :

Corrosive	<input type="radio"/>	Explosive	<input type="radio"/>
Biologically hazardous	<input type="radio"/>	Radioactive	<input type="radio"/>
Toxic	<input type="radio"/>		

In combination with which substances may hazardous mixtures develop?

Name of the substances : \_\_\_\_\_

Has the equipment been cleaned before shipment? YES  NO

Is the equipment decontaminated and not harmful to health? YES  NO

Prior to repair, radioactively contaminated components must be decontaminated according to the valid regulations for radiation protection.

**Legally Binding Declaration**

I / we hereby declare that the information on this declaration are correct and complete.

Company / Institute : \_\_\_\_\_

Street : \_\_\_\_\_

Postcode, City : \_\_\_\_\_

Tel. : \_\_\_\_\_ FAX : \_\_\_\_\_

Name : \_\_\_\_\_

Date : \_\_\_\_\_ Stamp : \_\_\_\_\_

Signature : \_\_\_\_\_



Please make some copies before removing this page.



